

Replace 12 Models with One Lamp

0-100% Smooth Triac & 0-10V Continuous Dimming

- 0-100% Smooth Triac & 0-10VDC Continuous Dimming without Flicker, Pulse, or Stepping
- Dual Wattage: 100W & 150W
- Color Selectable: 3000K-4000K-5000K
- High CRI: >90
- Universal Voltage: 100~277VAC
- Suitable for Dry & Damp Locations

US Patent D860,481

- Replace 12 Models with One Lamp - Lowest Total Cost of Ownership. Shortest Payback Period and High ROI. Zero Maintenance Costs.
- Versatile: Use as a Stand-alone Fixture or as a Replacement for HID, CFL and Halogen Lamps in existing Fixtures. Suitable for Fully Enclosed Fixtures.
- Designed for Reliability and Optimal Performance, HyLite LED Lotus Lamp features Excellent Optics for Increased Visibility, and Low Power Consumption. Designed for Easy Installation in New or Existing Fixtures HyLite LED Lotus Lamp supports 3-Color Temperature Adjustment, 2-Position Wattage Regulation.
- Compared to a Standard Incandescent or Halogen Lamp, the Lotus Lamp uses 90% less Energy than Halogen Lamps, thereby significantly reducing your Carbon Footprint and Relamping Costs, consequently decreasing Maintenance and Disposal Costs.
- High >90 CRI. Pleasing Light showing True Colors & Crisp, Flicker-free Lighting
- Universal Voltage: 100-277VAC. Safe & Reliable Isolated Circuit Design. Intelligent Temperature Control, Automatic Power Adjustment and Suitable for Higher Temperature Environment. Includes 4kV Surge Protection.
- Highest Lumen Efficacy of up to 164 LpW. Offers an Unprecedented Level of Light Output, Efficiency and Energy Savings that is Unmatched in the Industry.
- Available in Multiple Beam Angles (15°, 25°, 40°, & 120° - Spot Beam to Wide Floods) for Greater Light Control and Ideal Light Distribution.
- Easy Installation & Retrofitting: Simply Bypass Ballast and Screw-in.
- Cool Operation: Does not add to Heat Load while producing Brilliant Light.
- Ingress Protection: IP65 - Complete Protection against Contact, Dust Infiltration, and Water Splashes.
- Ultra-Long Design Life: Up to 60,000 hours*. Eliminate the hassle of Repeated Relamping.
- Flexible: Can be Mounted with Base Up, Down or Sideways. Adjustable Mounting for Directional Lighting.
- Solid-State: High-Shock and High-Vibration Resistant. Patented Passive Cooling Design: No Moving Parts for Longer Life. Fully Encapsulated with Heat and Impact Resistant, UV Protected, Non-yellowing, Optical Grade PC Lens.
- Instant Start & Restart: No Warm-up time required even in Extreme Cold.
- Waterproof Direct Wire Connection for Temporary or Portable Lighting.
- No Noise or RF Interference. No UV Emissions: Does Not attract Insects.
- Radiation/Emissions-Free: No Harmful IR, No RfI, EMI or HD
- Patented Technology Delivers Maximum, Lifetime Energy Savings
- No UV Emissions: Does Not attract Insects.
- Enhances Vision: Zero Dark Spots for greater Visibility & Safety.
- Safe: Contain No Hazardous Materials; RoHS Compliant: No Lead, Mercury, Toxic Metals or Arsenic Gases. No Disposal Requirements. Facilitates LEED® points.
- Environmentally Friendly: 98% of the HyLite Lotus Lamp is Recyclable.



SAVE UP TO 90% ON YOUR ENERGY COSTS

100W = 1000W Incandescent or PAR Halogen Equivalent

150W = 1500W Incandescent or PAR Halogen Equivalent

			→	
Incandescent or PAR Halogen	HID	CFL	Replace with	HyLite Lotus
1000W	500W	300W		100W
1500W	750W	450W	←	150W
90%	80%	67%		Energy Savings (%)*

* Does not include Ballast Loss, Maintenance and Replacement Lamp Savings and Disposal Costs which can amount to additional Savings of 30~50%!



Beam Angle Even & Uniform	Suitable For Enclosed Luminaires	Low Power & Longer Life Up to 60,000 Hours*	Energy Costs Reduction of up to 90%	Solid State Vibration and Shock Resistant	No EMI / RFI Zero Interference	No IR/UV Radiation-Free No Humming	High Efficacy Up to 164 LpW LM-79 Tested	Reliability LM-80 Tested ISTMT Tested	Warranty 5 Years Safe and Reliable
-------------------------------------	--	---	---	---	--	--	--	---	--

*Depending upon the ambient temperature of the installation location

Model No.	Watts	Delivered Lumens	Maximum Install Height	Input Line Current	Dimensions & Weight (each)		
					Diameter	Height	Weight
HL-LS-100150WD-EX-* -3050K	100W-150W	100W = 18,067 150W = 24,503	100W = <70 ft. (21m) 150W = <100 ft. (30m)	361~833mA 541~1250mA	8" (200mm)	7.6" (193mm)	2.2 lb. (1 kg.)
HL-LS-100150WD-GX-* -3050K							
HL-LS-100150WD-WC-* -3050K							

Ordering Information: * -15 (for Spot Beam); -25 (for Narrow Flood Beam); -40 (for Flood Beam); -120 (for Wide Flood Beam)

Standard Beam Angle: 120°

Legend: EX = With EX-39 (Mogul) Base GX = With GX16D Adapter WC = With WC2 Adapter

- Minimum Lamp Compartment Dimensions for Enclosed Fixtures: 18" x 18" x 18.5" (463mm x 463mm x 470mm)
- To Prevent early Lamp Failure, Lamp should only be installed in Operating Environments ranging from a Minimum of -25°C (-13°F) to a maximum of +45°C (113°F).
- 0-100% Smooth Triac or 0-10VDC Continuous Dimming without Flicker, Pulse, or Stepping
- Universal Voltage: 100~277VAC
- Rated Life: 50~60,000 Hrs.*
- Ambient Working Temp.: -13°F~+113°F (-25°C~+45°C)
- 3000°K~4000°K~ 5000°K Standard CCT.
Products with 2400°-6500°K (CCT) are available as "Special Orders" only and with Longer Lead Times
- Efficacy: Up to 164 LpW
- High CRI: >90+
- Protection: IP65
- Max. THD (%): <20%
- Power Factor: >0.9
- Warranty: 5 Years
- Safety Cable Included
- Standard Beam Angle: 120°

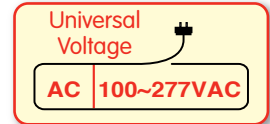

* Depending upon the ambient temperature of the installation location



WARNING!
Minimum Lamp Compartment Size
18" x 18" x 18.5" (463mm x 463mm x 470mm)
Caution: The Lamp has been provided with a Safety Cable. It is Imperative to Secure Safety Cable to the Lamp and to a Permanent Secure Location for Safety.

Dimensions: (Shown with EX-39 [Mogul] Base)

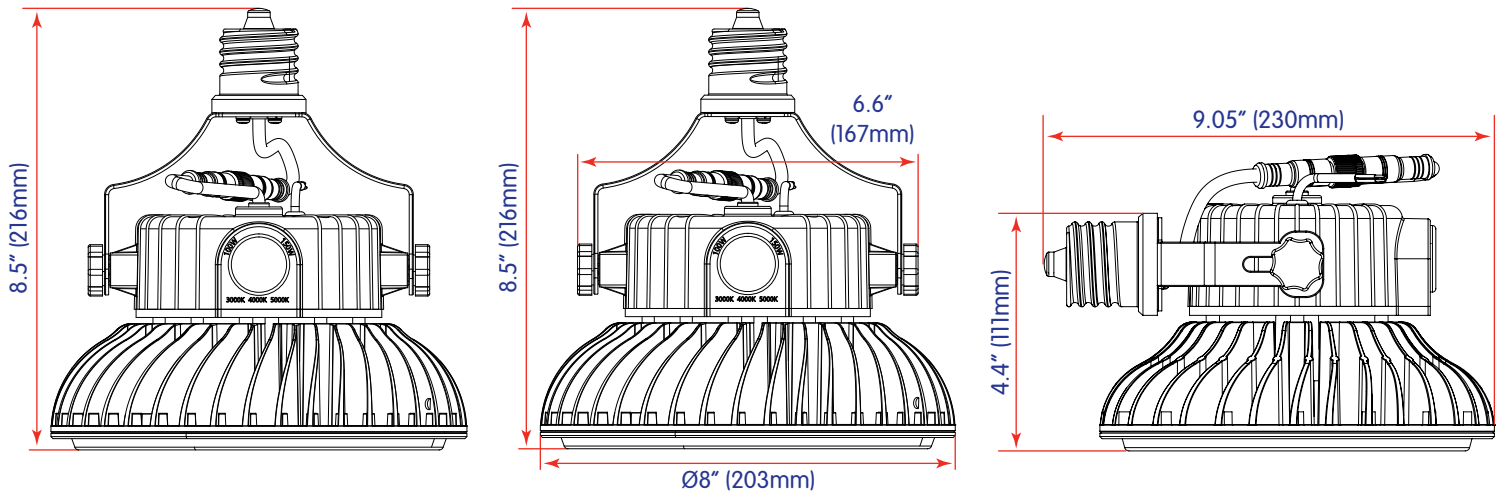

U.S. Patents: US D860,481 S and US D860,481 S-1

HyLite is providing this information to the general public only. Please note that all products contained herein are either Trademarked, Copyrighted, and/or have Patents or Patents Pending. Any use of these Designs is Strictly Prohibited. HyLite LED, LLC. Protects its Proprietary Information Vigorously in the Courts of the United States of America.

Installation: HyLite LED Lotus Dimmable Lamps are Suitable for Use with 100~277VAC Input Voltage. Ballast (if equipped) must be Bypassed or Removed from the Fixture before installing the Lamp. Eliminating the Ballast saves Additional Costs related to Maintenance, Energy Consumption and Performance. By-passing Ballast will also ensure that there is no EMI/RF interference.

Warning: Failure to follow these Instructions will result in a Damaged Product and will VOID Warranty. It could also result in an Electric Shock, or Fire.



NO
LEAD, MERCURY,
HEAVY METALS
OR TOXIC GASES



98%
RECYCLABLE

Ideal for High-Quality illumination in:

- High Ceilings
- Studio Lighting
- Track Lighting
- Stage Lighting
- Spot Lighting
- Down Lights
- Accent Lighting
- Flood Lighting
- Low & High Bay Lighting
- Canopy Lights
- Decorative Lighting
- Site Lighting
- Pendant Lights
- Freezer & Cold Storage Lights
- Barn Lights



Multiple Beam Angles for Ideal Light Distribution

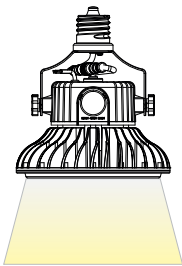

15° - Spot Beam

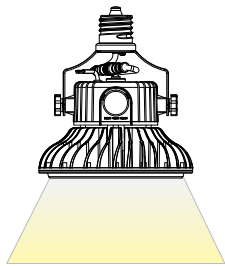

25° - Narrow Flood Beam

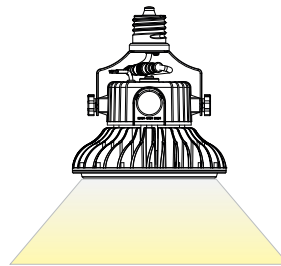

40° - Flood Beam

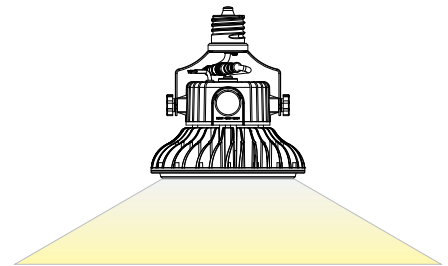

120° - Wide Flood Beam

Versatile and Adjustable - Use in Multiple Positions, Different Lengths and Various Angles for Directional Lighting



Multiple Adjustable Lengths
to Suit Tight Spaces

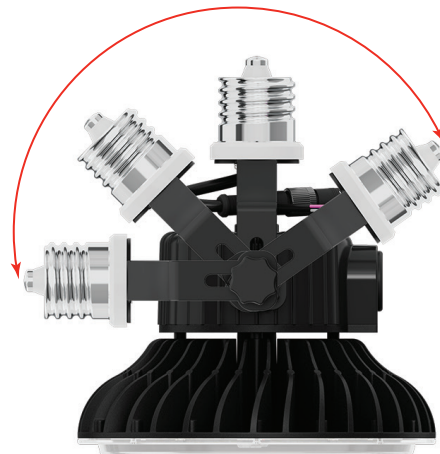

SAVE UP TO
90%
ON YOUR
ENERGY COSTS

LED
Lotus Lamp™
Dual Wattage
100W-150W

0-100%
Smooth
Triac & 0-10V
Continuous
Dimming

Adjustable Angle for Directional Lighting
- Orient in any Position for Maximum Luminance

Proprietary
& Patented
Design

Multi-CCT
3000K
4000K
5000K

Dual Wattage and Color Selectable

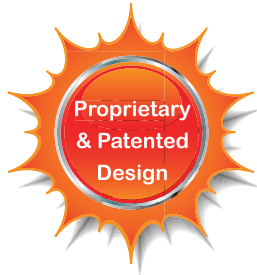

Versatile - Can be Used with Multiple Connectors: Screw-in with EX-39 (Mogul) Base, with GX16D Adapter or with WC2 (Pigtail) Adapter



Lotus Lamp with EX-39 (Mogul) Base

Quick Adapters



HL-QA-GX16D-LS
GX16D Quick Adapter



Lotus Lamp with GX16D Quick Adapter



HL-LS-WC2
2 Ft. (60cm)
Whip Connector
Quick Adapter



Lotus Lamp with WC2 Quick Adapter